

Each pole contact equipped with arc extinguish system , can eliminate arc immediately when switch off

# DC ISOLATOR

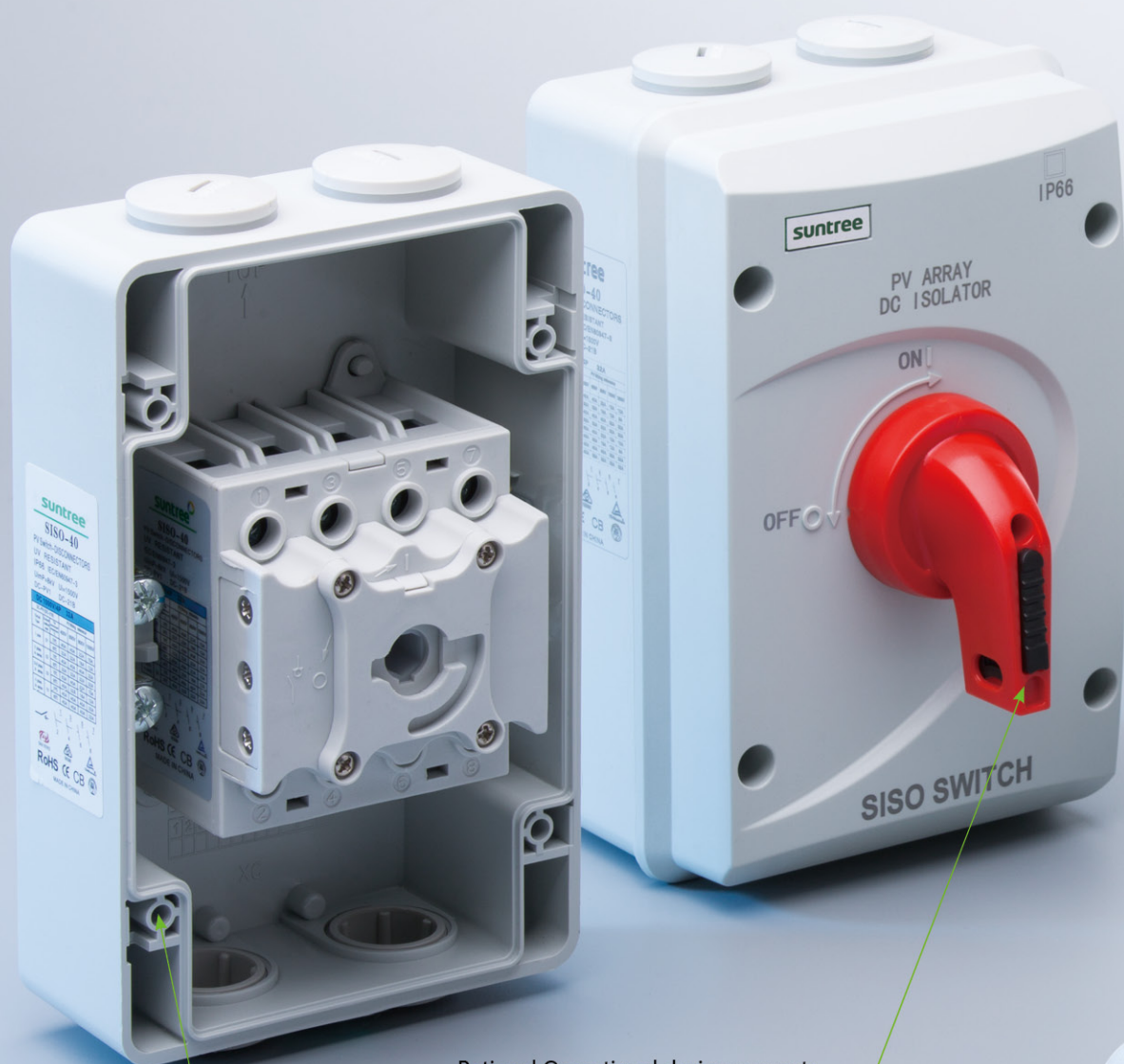

Rational Operational design prevents, reverse/ incorrect rotation

Wall-mounted design, No need to open the cover mounting, Flexible installation



# SWITCH

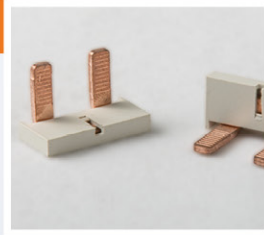

with bus-bar

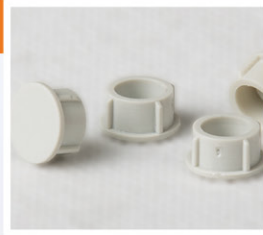

Waterproof cover



Can connect to the MC4 connectors



## DC distribution PV system used disconnector

### System requirements

Generally speaking, the voltage on DC side of PV system usually is higher, could be as high as 1000VDC. So we need switchgear of  $U_e=1000\text{VDC}$ . The branch circuit in combiner box needs protection, while the main circuit equipments in combiner box and DC cabinet need isolating function 1. Switching with load of 1000VDC or remote operation function. In addition, it needs to install switchgear 2 on DC side of inverter cabinet to switch with loads, plays a role of isolation for overhauling.

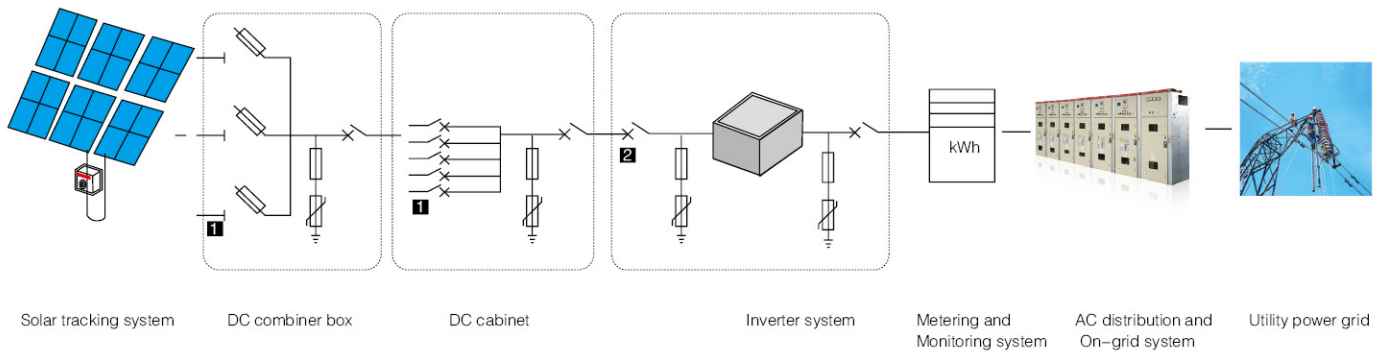

### Flow chart

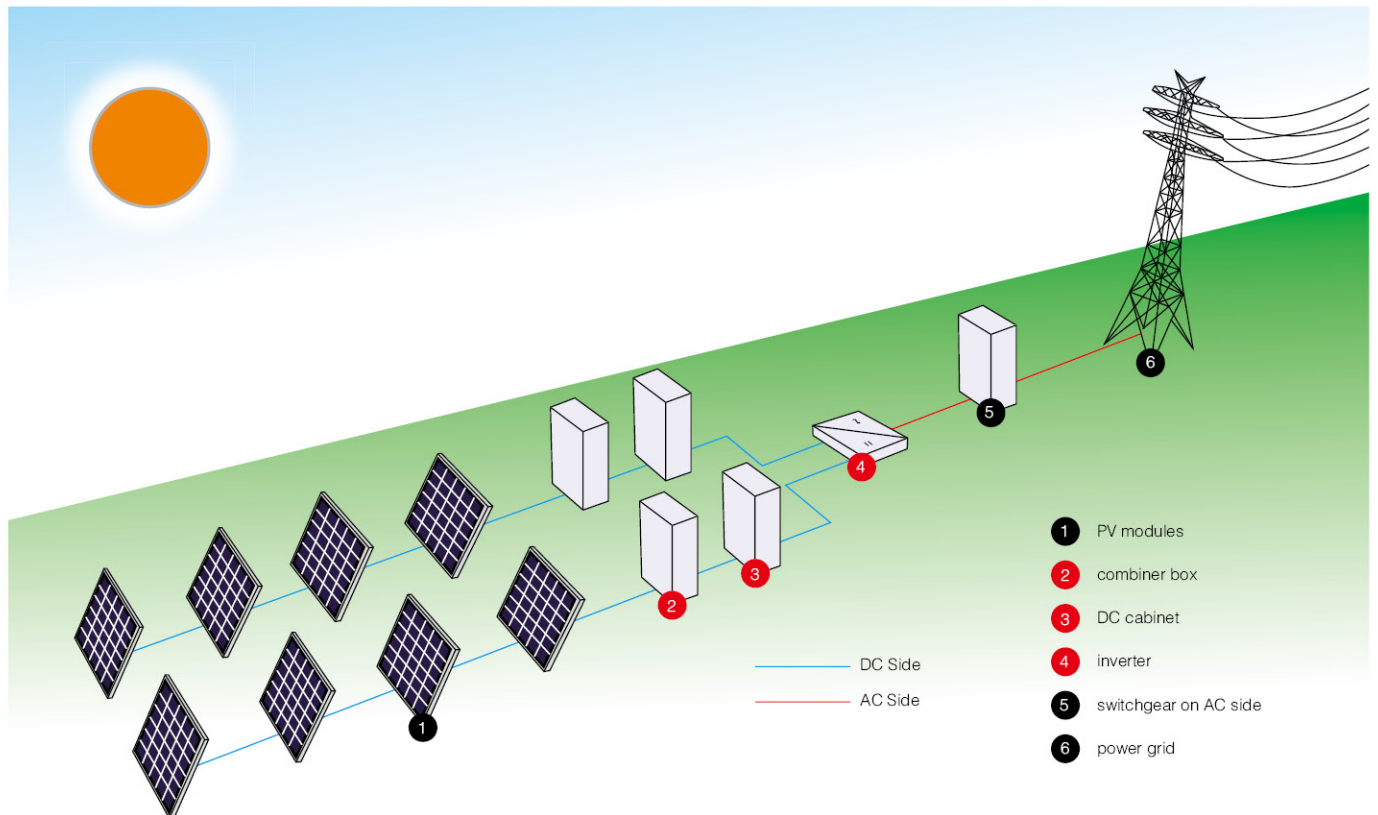



SISO-40



SISO-40

## DC ISOLATING SWITCH

- UV Resistant IP66 Enclosure
- Extremely Short Power Shut Off Time Of Approx.2ms
- Lid Only Removable In “off” Position
- Earth Terminal
- IEC60947-3,AS/NZS60947.3: 2015
- DC-PV1 DC-PV2 DC-21B
- 10A To 32A UP To DC1200v
- Easy To Install



### Specifications

Rated Voltage	1000VDC TO 1200VDC
IP Rating	IP66
Connection Type	M20 M25 MC4
Rated Current	10A, 16A, 20A, 25A, 32A
Working Temperature	-25°C~+85°C
Standard	IEC60947-3, AS/NZS60947.3:2015

This product passed IEC authorized Lab IP66 waterproof testing. Also our company will take simulation tests irregularly, similar to customer's using environment, to make sure this product completely conforms to IP66 protection grade

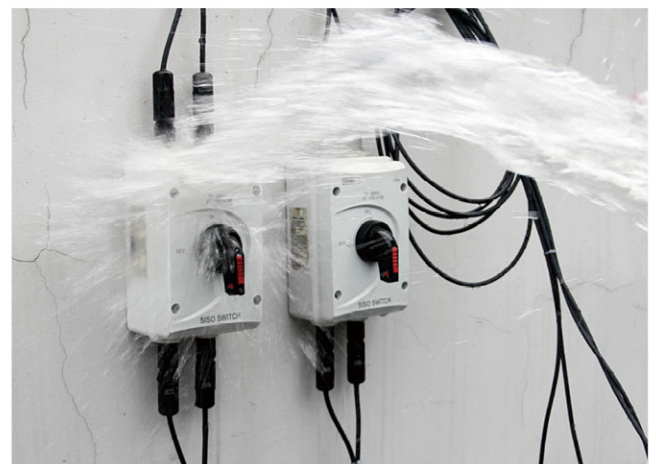

## Specifications

Contact configuration	600V	800V	1000V	1200V	Poles in series	Number of strings	Type Number
	16A	16A	9A	9A	2	1	SISO-16P2
	25A	20A	11A	11A	2	1	SISO-25P2
	32A	23A	13A	13A	2	1	SISO-32P2
	29A	16A	9A	9A	2	1	SISO-16P2H
	45A	20A	11A	11A	2	1	SISO-25P2H
	50A	23A	13A	13A	2	1	SISO-32P2H
	16A	16A	9A	9A	2	2	SISO-16P4
	25A	20A	11A	11A	2	2	SISO-125P4
	32A	23A	13A	13A	2	2	SISO-32P4
	16A	16A	16A	16A	4	1	SISO-16P4S
	25A	25A	25A	25A	4	1	SISO-25P4S
	32A	32A	32A	32A	4	1	SISO-32P4S
	16A	16A	16A	16A	4	1	SISO-16P4B
	25A	25A	25A	25A	4	1	SISO-25P4B
	32A	32A	32A	32A	4	1	SISO-32P4B
	16A	16A	16A	16A	4	1	SISO-16P4T
	25A	25A	25A	25A	4	1	SISO-25P4T
	32A	32A	32A	32A	4	1	SISO-32P4T

1500V DC voltage require customized

### Contact Configuration

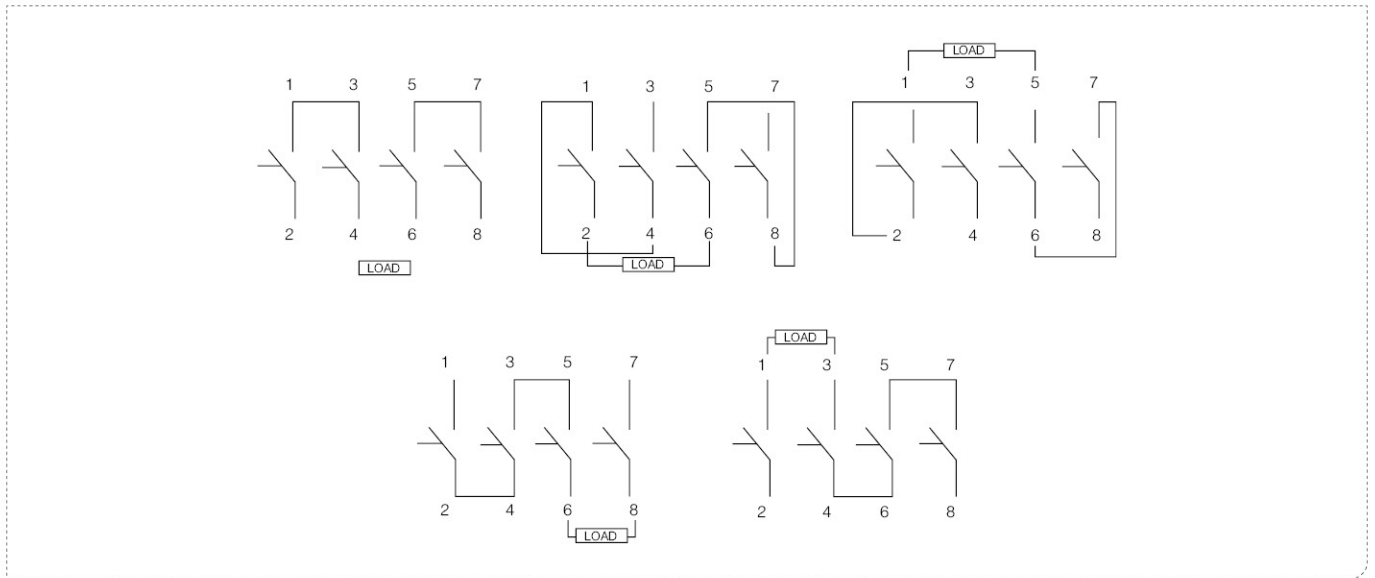

### Dimensions(mm)

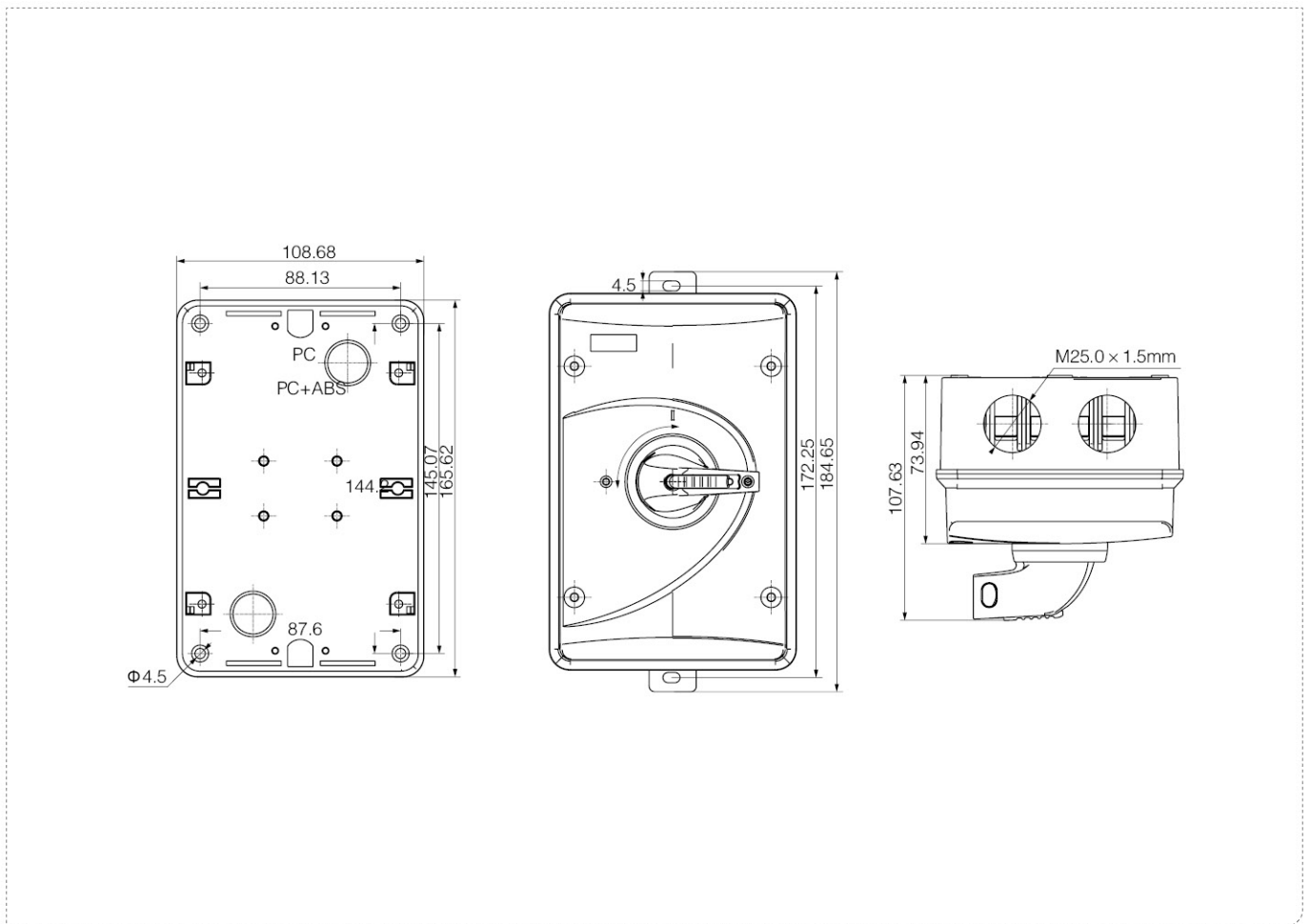



## Main Switch for DIN Rail Mounting

- DIN rail mounting
- Extremely short power shut off time of approx. 3ms
- 2 poles and 4 poles available
- IEC60947-3 standard
- DC21B: 16A, 25A and 32A up to 1500V DC









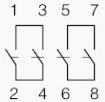

### Specifications

Contact configuration	600V	800V	1000V	1200V	Poles In series	Number of strings	Type Number
	32A	32A	23A	13A	2	2	SISO.4-32MD-B
	16A	16A	16A	9A	2	2	SISO.4-16MD-B
	16A	16A	16A	9A	2	1	SISO.2-16 D2
	25A	25A	20A	11A	2	1	SISO.2-25 D2
	32A	32A	23A	13A	2	1	SISO.2-32 D2
	29A	29A	16A	9A	2	1	SISO.2-16 D2H
	45A	45A	20A	11A	2	1	SISO.2-25 D2H
	58A	58A	23A	13A	2	1	SISO.2-32 D2H
	16A	16A	16A	9A	2	2	SISO.2-16 D4
	25A	25A	20A	11A	2	2	SISO.2-25 D4
	32A	32A	23A	13A	2	2	SISO.2-32 D4
	16A	16A	16A	16A	4	1	SISO.2-16 D4S
	25A	25A	25A	25A	4	1	SISO.2-25 D4S
	32A	32A	32A	32A	4	1	SISO.2-32 D4S
	16A	16A	16A	16A	4	1	SISO.2-16 D4B
	25A	25A	25A	25A	4	1	SISO.2-25 D4B
	32A	32A	32A	32A	4	1	SISO.2-32 D4B
	16A	16A	16A	16A	4	1	SISO.2-16 D4T
	25A	25A	25A	25A	4	1	SISO.2-25 D4T
	32A	32A	32A	32A	4	1	SISO.2-32 D4T

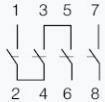
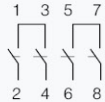
1500V DC voltage require customized

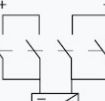
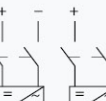
## Main Switch for DIN Rail Mounting

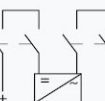
### Switching Configurations

Type	2-pole	2-pole 4 paralleled poles	4-pole	4-pole with Input on top output bottom	4-pole with Input and output bottom	4-pole with Input and output on top
SISO.2-16	2	2H	4	4S	4B	4T
SISO.2-25	2	2H	4	4S	4B	4T
SISO.2-32	2	2H	4	4S	4B	4T
Contacts Wiring graph						
Switching example						

### Dimensions(mm)

